

PONY | JORGENSEN

Clamps without compromise.

Since 1903



PRODUCT CATALOG
SPRING, 2024



METICULOUS ATTENTION TO EVERY DETAIL

Since 1903, Pony Jorgensen has provided craftspeople from all walks of life with clamps that are crafted differently. And to this day, making high-quality clamps is still our driving passion. First, we source materials that meet our exacting standards. Our bar clamps are made with high-carbon rust-resistant steel, and only the finest seasoned, straight-grain North American maple wood makes it into our iconic Jorgensen handscrews.

Then, we manufacture our clamps under strict guidelines and inspect each one to guarantee consistency and performance. Pony Jorgensen clamps are crafted with only the highest-quality materials because our mission is simple – to serve customers by providing the best products with the most trusted reputation in the industry.





PIPE CLAMPS

Trust America's most popular and widely used pipe clamp fixture with your next woodworking projects and see why Pony Jorgensen original pipe clamps are the tried and true choice. Made with our original steel multiple-disc clutch for unmatched versatility on any length pipe.



Classic Pony Pipe Clamp Fixture for 3/4-Inch Black Pipe

The iconic Pony 3/4-inch pipe clamp has become America's most popular and widely used pipe clamp fixture design. Our original steel multiple-disc-clutch design allows a secure hold and instant adjustment at any point along the pipe, without fear of slipping or pipe crushing. Use any length of 3/4-inch black pipe, as long as the pipe is seven inches longer than your workpiece. Crafted with strong, durable iron casting. Clamping face is approx. 1 3/4 inches square.



SPECS

Product Number	Handle	Pipe Used
50	Crank	3/4" - 14 NPT Pipe



Pony Pipe Clamp Fixtures feature the original Multiple-Disc-Clutch design which allows a secure hold and instant adjustment at any point along the pipe.

Pony Professional Pipe Clamp Fixture

The heavy-duty version of our original Pony pipe clamp fixture comes with a longer acme-threaded screw, a wider, taller stance, and a built-in clamp hanger for more-demanding projects, including industrial applications. Clamping face is approx. 2 inches square.

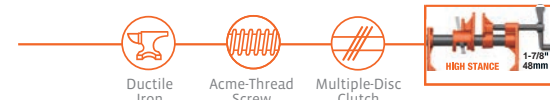

SPECS

Product Number	Handle	Pipe Used
55	Crank	3/4" - 14 NPT Pipe



Pony High Stance Pipe Clamp Fixture

The Pony high stance pipe clamp fixture provides superior clearance from the work surface to allow the crank handle to clear the workstation when opening and closing the clamp. No need to position clamp handle off edge of bench. It is one of the handiest tool in any workshop.

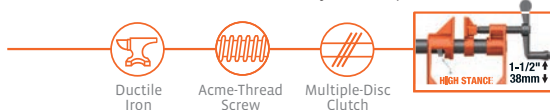

SPECS

Product Number	Handle	Pipe Used
50P	Crank	3/4" - 14 NPT Pipe

Pony Deep-Reach Pipe Clamp Fixture

Our deep-reach pipe clamp fixture features a reach of 2 1/2 inches. Reverse the heads to easily turn it into a spreader clamp. Ideal for use in tight quarters.



SPECS

Product Number	Handle	Pipe Used
56	Wing nut	3/4" - 14 NPT Pipe



Pony Pipe Clamp Fixture for 1/2-Inch Black Pipe

Enjoy the trusted strength, reliability, and features of our original Pony pipe clamp fixtures with any length of 1/2-inch black pipe. Ideal for small and light-duty projects. Clamping face is approx. 1 1/2 inches square.



SPECS

Product Number	Handle	Pipe Used
52	Sliding pin	1/2" - 14 NPT Pipe

Pony Pipe Clamp Pads

Our clamp pads eliminate the need for wood blocks by adding soft, durable plastic padding to your clamps that provides a resilient nonstick, nonslip protective cushion when clamping wood, metal, and plastic surfaces. Recommended for use with pipe clamp fixtures #50, #50P, #52 and #55, as well as 3500- and 7200-series bar clamps.

SPECS

Product Number	Fits
7456	#50, #50P, #7200
7452	#52, #3500
7455	#55





BAR CLAMPS

Pony Jorgensen offers a wide range of bar clamps ideal for DIYers, hobbyists, woodworkers, carpenters, cabinetmakers, metalworkers, and everyone in between.

Made with high-quality aluminum and steel to last as long as the pieces you craft.



Jorgensen Heavy Duty E-Z HOLD® Expandable Bar Clamp

Our Jorgensen heavy-duty E-Z HOLD® expandable bar clamps come with all the great features of our medium- and light-duty E-Z HOLD® expandable bar clamps, but they have a slightly larger reach and double the clamping force – 600 pounds! Made with durable materials, these clamps are serious workhorses for serious woodworkers.



Patented Feature



Ergonomic Grip

SPECS

Product Number	Max Opening	Reach	Clamping Force	Handle
33706	6 in.	3 5/8 in.	600 lb.	Grip lever
33712	12 in.	3 5/8 in.	600 lb.	Grip lever
33718	18 in.	3 5/8 in.	600 lb.	Grip lever
33724	24 in.	3 5/8 in.	600 lb.	Grip lever
33736	36 in.	3 5/8 in.	600 lb.	Grip lever
33750	50 in.	3 5/8 in.	600 lb.	Grip lever



Jorgensen Medium Duty E-Z HOLD® Expandable Bar Clamp

Unique Jorgensen E-Z HOLD® bar clamps allow for rapid and easy clamping and can easily be converted to spreader clamps. The contoured comfort grip and quick-release lever make it simple to get a firm grasp, and our exclusive patented feature lets you join two clamps together to create a clamp with more than double the opening capacity of a single clamp. Deep-reach pads help protect your work.

• Best Clamps - GEAR OF THE YEAR - Popular Mechanics 2021



Patented Feature



Ergonomic Grip

SPECS

Product Number	Max Opening	Reach	Clamping Force	Handle
33406	6 in.	3 3/8 in.	300 lb.	Grip lever
33412	12 in.	3 3/8 in.	300 lb.	Grip lever
33418	18 in.	3 3/8 in.	300 lb.	Grip lever
33424	24 in.	3 3/8 in.	300 lb.	Grip lever
33436	36 in.	3 3/8 in.	300 lb.	Grip lever



Jorgensen's exclusive patented feature lets you join two clamps together to create a clamp with more than double the opening capacity of a single clamp.



Jorgensen Light Duty E-Z HOLD® Expandable Bar Clamp

The most popular E-Z Hold® Clamp. It is ideal for light duty woodworking, hobby, craft and model projects. It can also be converted to a spreader clamp. Features include easy/comfortable one-handed clamping, 2-1/2 in. jaw reach with protective pads, contoured comfort grip and quick release lever.



Patented Feature



Ergonomic Grip

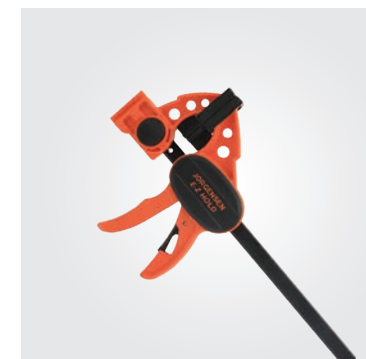

SPECS

Product Number	Max Opening	Reach	Clamping Force	Handle
33606	6 in.	2 1/2 in.	150 lb.	Grip lever
33612	12 in.	2 1/2 in.	150 lb.	Grip lever
93365	2PK Clamp Set 33612 x 2			
93366	2PK Clamp Set 33606 x 2			

Jorgensen E-Z HOLD® Hobby/Craft Bar Clamp

Our most affordable E-Z HOLD® bar clamps are ideal for hobby and craft projects. They come with all the same features of our medium- and light-duty E-Z HOLD® clamps, except for the ability to join two clamps together.



Ergonomic Grip

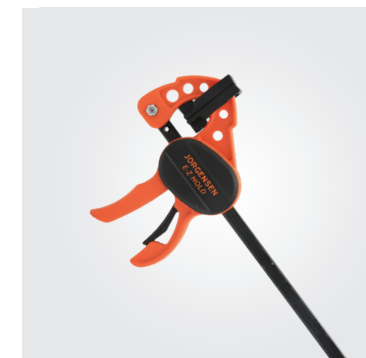

SPECS

Product Number	Max Opening	Reach	Clamping Force	Handle
33804	4 in.	1 1/2 in.	50 lb.	Grip lever
33808	8 in.	1 1/2 in.	50 lb.	Grip lever
93367	2PK Clamp Set 33804 x 2			



Jorgensen E-Z Hold® Platinum Series Expandable Bar Clamp

Reach for the Jorgensen E-Z Hold® Platinum Series Trigger Clamp for industrial and professional applications. The durable aluminum body withstands tremendous clamping pressure and is designed with a clamping force indicator that helps quickly identify the desired clamping force. The exclusive patented feature lets you join two clamps to create a more oversized clamp with more than double the opening capacity of a single clamp. Other features include easy/comfortable one-handed clamping, 3-1/8 in. jaw reach with protective pads, quick release lever, ergonomically contoured comfort grip, and can easily be converted to spreader clamps.



Product Number	Max Opening	Reach	Clamping Force	Handle
33906	6 in.	3 1/8 in.	400 lb.	Grip lever
33912	12 in.	3 1/8 in.	400 lb.	Grip lever
33918	18 in.	3 1/8 in.	400 lb.	Grip lever
33924	24 in.	3 1/8 in.	400 lb.	Grip lever
33936	36 in.	3 1/8 in.	400 lb.	Grip lever

Jorgensen Precision Medium Duty E-Z HOLD® Expandable Bar Clamp

Having the issue of drying the glue by over clamping? Not any more with Jorgensen precision EZ Hold® clamp. It provides the precision scale for proper clamping force applied. Genuine designed Large clamping force indicator allows to easily identify the proper clamping force applied. Comes with all other EZ Hold® Clamp features.



Product Number	Max Opening	Reach	Clamping Force	Handle
33506	6 in.	3 3/8 in.	300 lb.	Grip lever
33512	12 in.	3 3/8 in.	300 lb.	Grip lever
33518	18 in.	3 3/8 in.	300 lb.	Grip lever
33524	24 in.	3 3/8 in.	300 lb.	Grip lever
33536	36 in.	3 3/8 in.	300 lb.	Grip lever



Jorgensen Work-Protecting Bar Clamp Pads

Our clamp pads eliminate the need for wood blocks by adding soft, durable plastic padding to your clamps and providing a resilient, nonstick, nonslip protective cushion when clamping wood, metal, and plastic surfaces.



Product Number	Fits
7460	#33804, #33808
7461	#33606, #33612
7462	#33406, #33412, #33418, #33424, #33436
7463	#33706, #33712, #33718, #33724, #33736, #33750
7468	#33906, #33912, #33918, #33924, #33936 #33506, #33512, #33518, #33524, #33536



Jorgensen Steel Bar Clamp

Jorgensen steel bar clamps are seriously strong. Cast-iron stationary and sliding heads with an orange-powder-coated finish are merged with a high-carbon rust-resistant steel bar that packs a whopping 85,000 pounds per square inch of tensile strength. The fast-acting sliding head is acme threaded to accommodate a cold-drawn steel screw with a large easy-grip handle and swivel pad. And our original multiple-disc-clutch design allows the sliding head to hold securely at any point along the bar. Available in a wide variety of sizes and clamping forces for light-duty, medium-duty, and heavy-duty applications.



HEAVY DUTY

Product Number	Max Opening	Reach	Clamping Force	Bar
3706-HD	6 in.	3 in.	1,000 lb.	1 x 5/16 in.
3712-HD	12 in.	3 in.	1,000 lb.	1 x 5/16 in.
3718-HD	18 in.	3 in.	1,000 lb.	1 x 5/16 in.
3724-HD	24 in.	3 in.	1,000 lb.	1 x 5/16 in.
3730-HD	30 in.	3 in.	1,000 lb.	1 x 5/16 in.
3736-HD	36 in.	3 in.	1,000 lb.	1 x 5/16 in.

MEDIUM DUTY

Product Number	Max Opening	Reach	Clamping Force	Bar
3706	6 in.	2 1/2 in.	600 lb.	3/4 x 1/4 in.
3712	12 in.	2 1/2 in.	600 lb.	3/4 x 1/4 in.
3718	18 in.	2 1/2 in.	600 lb.	3/4 x 1/4 in.
3724	24 in.	2 1/2 in.	600 lb.	3/4 x 1/4 in.
3730	30 in.	2 1/2 in.	600 lb.	3/4 x 1/4 in.
3736	36 in.	2 1/2 in.	600 lb.	3/4 x 1/4 in.
93700	4PK Clamp Set 3706 x 2, 3712 x 2			

LIGHT DUTY

Product Number	Max Opening	Reach	Clamping Force	Bar
3704-LD	4 in.	2 in.	300 lb.	5/8 x 3/16 in.
3706-LD	6 in.	2 in.	300 lb.	5/8 x 3/16 in.
3708-LD	8 in.	2 in.	300 lb.	5/8 x 3/16 in.
3712-LD	12 in.	2 in.	300 lb.	5/8 x 3/16 in.



Pony Jorgensen Work-Protecting Bar Clamp Pads

Our clamp pads eliminate the need for wood blocks by adding soft, durable plastic padding to your clamps that provides a resilient nonstick, nonslip protective cushion when clamping wood, metal, and plastic surfaces. Can be added to many Jorgensen bar clamps.

Product Number	Fits
7437	#3700, #3700-LD
7438	#3700-HD

Jorgensen deep-reach throat bar clamp

When your project calls for a deeper hold, reach for Jorgensen deep throat steel bar clamps. They contain all the same high-quality materials as our traditional steel bar clamps but with five-inch, seven-inch, and nine-inch reaches. And welders take note: the copper-plated screws, handles, and swivels help protect against weld spatter in welding jobs.



FIVE INCH

Product Number	Max Opening	Reach	Clamping Force	Handle	Bar
4506	6 in.	5 in.	1,200 lb.	Soft grip	1 3/8 x 5/16 in.
4508	8 in.	5 in.	1,200 lb.	Soft grip	1 3/8 x 5/16 in.
4512	12 in.	5 in.	1,200 lb.	Soft grip	1 3/8 x 5/16 in.
4518	18 in.	5 in.	1,200 lb.	Soft grip	1 3/8 x 5/16 in.
4524	24 in.	5 in.	1,200 lb.	Soft grip	1 3/8 x 5/16 in.
4530	30 in.	5 in.	1,200 lb.	Soft grip	1 3/8 x 5/16 in.
4536	36 in.	5 in.	1,200 lb.	Soft grip	1 3/8 x 5/16 in.
4548	48 in.	5 in.	1,200 lb.	Soft grip	1 3/8 x 5/16 in.
4560	60 in.	5 in.	1,200 lb.	Soft grip	1 3/8 x 5/16 in.

SEVEN INCH

Product Number	Max Opening	Reach	Clamping Force	Handle	Bar
4708	8 in.	7 in.	1,200 lb.	Soft grip	1 1/2 x 3/8 in.
4712	12 in.	7 in.	1,200 lb.	Soft grip	1 1/2 x 3/8 in.
4718	18 in.	7 in.	1,200 lb.	Soft grip	1 1/2 x 3/8 in.
4724	24 in.	7 in.	1,200 lb.	Soft grip	1 1/2 x 3/8 in.
4730	30 in.	7 in.	1,200 lb.	Soft grip	1 1/2 x 3/8 in.
4736	36 in.	7 in.	1,200 lb.	Soft grip	1 1/2 x 3/8 in.
4748	48 in.	7 in.	1,200 lb.	Soft grip	1 1/2 x 3/8 in.
4760	60 in.	7 in.	1,200 lb.	Soft grip	1 1/2 x 3/8 in.
4772	72 in.	7 in.	1,200 lb.	Soft grip	1 1/2 x 3/8 in.

NINE INCH

Product Number	Max Opening	Reach	Clamping Force	Handle	Bar
4908	8 in.	9 in.	1,200 lb.	Steel sliding pin	1 1/2 x 3/8 in.
4912	12 in.	9 in.	1,200 lb.	Steel sliding pin	1 1/2 x 3/8 in.
4918	18 in.	9 in.	1,200 lb.	Steel sliding pin	1 1/2 x 3/8 in.
4924	24 in.	9 in.	1,200 lb.	Steel sliding pin	1 1/2 x 3/8 in.
4936	36 in.	9 in.	1,200 lb.	Steel sliding pin	1 1/2 x 3/8 in.
4948	48 in.	9 in.	1,200 lb.	Steel sliding pin	1 1/2 x 3/8 in.
4960	60 in.	9 in.	1,200 lb.	Steel sliding pin	1 1/2 x 3/8 in.
4972	72 in.	9 in.	1,200 lb.	Steel sliding pin	1 1/2 x 3/8 in.



Jorgensen Cabinet Master™ 90° Parallel Jaw Bar Clamp

The Jorgensen Cabinet Master 90° parallel jaw bar clamp is a cabinetmaker's best friend. Its large jaws distribute clamping pressure over wide areas and stay parallel to ensure square corners and prevent workpieces from bowing or lifting. This makes it the perfect clamp for flat-panel, box, cabinet, frame, and panel-door assemblies – or any project that requires squareness or evenly applied pressure. A built-in clamp stand allows for one-handed use and quicker sliding-head adjustment. Want to use it as a spreader? Just reverse the sliding head.



Steel Bar



Cold-Drawn ACME Screw

SPECS

Product Number	Max Opening	Reach	Clamping Force	Handle	Bar
8012	12 in.	3 7/8 in.	1,500 lb.	Soft grip	1 3/16 x 3/8 in.
8018	18 in.	3 7/8 in.	1,500 lb.	Soft grip	1 3/16 x 3/8 in.
8024	24 in.	3 7/8 in.	1,500 lb.	Soft grip	1 3/16 x 3/8 in.
8030	30 in.	3 7/8 in.	1,500 lb.	Soft grip	1 3/16 x 3/8 in.
8036	36 in.	3 7/8 in.	1,500 lb.	Soft grip	1 3/16 x 3/8 in.
8048	48 in.	3 7/8 in.	1,500 lb.	Soft grip	1 3/16 x 3/8 in.
8060	60 in.	3 7/8 in.	1,500 lb.	Soft grip	1 3/16 x 3/8 in.
8072	72 in.	3 7/8 in.	1,500 lb.	Soft grip	1 3/16 x 3/8 in.

Jorgensen Industrial Steel I-Bar Clamp

There's a reason Jorgensen I-bar clamps are our most popular heavy-duty steel bar clamps. The special steel I-bar design is tremendously strong and stiff, and the clamp head is fixed for maximum resilience. A cold-drawn steel screw with smoothly cut acme threads attaches to ductile cast-iron castings to complete the clamp. Depend on this clamp to withstand the rigorous daily demands of school shops, commercial woodworking operations, metalworking factories, welding applications, and serious woodworking applications.



Alloy Steel



Cold-Drawn ACME Screw



Multiple-Disc Clutch



SPECS

Product Number	Max Opening	Reach	Clamping Force	Handle	Bar
7224	24 in.	2 in.	7,000 lb.	Crank	1 1/2 x 7/16 in.
7230	30 in.	2 in.	7,000 lb.	Crank	1 1/2 x 7/16 in.
7236	36 in.	2 in.	7,000 lb.	Crank	1 1/2 x 7/16 in.
7248	48 in.	2 in.	7,000 lb.	Crank	1 1/2 x 7/16 in.
7260	60 in.	2 in.	7,000 lb.	Crank	1 1/2 x 7/16 in.
7272	72 in.	2 in.	7,000 lb.	Crank	1 1/2 x 7/16 in.
7284	84 in.	2 in.	7,000 lb.	Crank	1 1/2 x 7/16 in.
7296	96 in.	2 in.	7,000 lb.	Crank	1 1/2 x 7/16 in.

Jorgensen Aluminum Bar Clamp

Jorgensen aluminum bar clamps have an excellent strength-to-weight ratio, making these strong, lightweight bar clamps perfect for both commercial and DIY applications. The bars are crafted from an anodized rust-resistant aluminum, and their rectangular design creates a stable clamping surface for edge-gluing. The tail-stop's trigger spring takes advantage of notches on the bar to lock into place.



Anodized Aluminum



Acme-Thread Screw



SPECS

Product Number	Max Opening	Reach	Clamping Force	Handle	Bar
3524	24 in.	1 5/8 in.	1,000 lb.	Sliding pin	1 5/16 x 13/16 in.
3536	36 in.	1 5/8 in.	1,000 lb.	Sliding pin	1 5/16 x 13/16 in.
3548	48 in.	1 5/8 in.	1,000 lb.	Sliding pin	1 5/16 x 13/16 in.
3560	60 in.	1 5/8 in.	1,000 lb.	Sliding pin	1 5/16 x 13/16 in.
3572	72 in.	1 5/8 in.	1,000 lb.	Sliding pin	1 5/16 x 13/16 in.



Jorgensen Gear Clamp

Lightweight Jorgensen gear clamps are ideal for projects that require constant use of clamping and unclamping. A distinctive power bar design allows for rapid action, and a handy quick-release button allows for the instant release of clamping pressure.



Steel Frame



Rapid Action

SPECS

Product Number	Max Opening	Reach	Clamping Force
38004	4 in.	3 in.	600 lb.
38008	8 in.	3 in.	600 lb.
38012	12 in.	3 in.	600 lb.

Jorgensen Drop-Forged Heavy-Duty Bar Clamp

For hobbyists, carpenters, cabinetmakers, woodworkers, metalworkers, and professional tradespeople seeking a bar clamp with superior rust resistance, look no further than the Jorgensen drop-forged bar clamp. The drop-forged steel bar is chrome plated to ward off rust longer, and a heat-treated acme screw provides increased durability.



Drop-Forged Steel



Acme-Thread Screw



Chrome Plated



SPECS

Product Number	Max Opening	Reach	Clamping Force	Handle	Bar
75306	6 in.	3 in.	450 lb.	Steel sliding pin	1/4 x 5/8 in.
75312	12 in.	3 in.	450 lb.	Steel sliding pin	1/4 x 5/8 in.
75318	18 in.	3 in.	450 lb.	Steel sliding pin	1/4 x 5/8 in.
75418	18 in.	4 1/2 in.	1,000 lb.	Steel sliding pin	3/8 x 7/8 in.

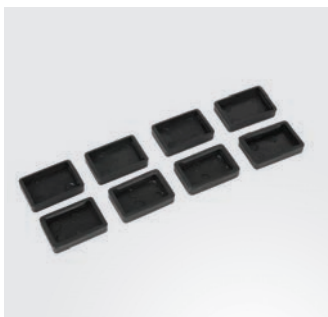

Jorgensen Work-Protecting Bar Clamp Pads

Our clamp pads eliminate the need for wood blocks by adding soft, durable plastic padding to your clamps and providing a resilient, nonstick, nonslip protective cushion when clamping wood, metal, and plastic surfaces.

SPECS

Product Number	Fits
7473	#38004, #38008, #38012





C-CLAMPS

Pony Jorgensen carries a wide range of high-quality C-clamps with features like acme-threaded screws and heat-treated steel frames to fit the needs of any woodworker or welder for hobby, light-duty, and heavy-duty applications.



Classic Pony Light-Duty C-Clamp

Discover America's most popular and complete line of light-duty C-clamps. The smoothly cut acme-threaded steel screw is protected with a black-oxide finish for lasting durability. And the clamp casting is made with ductile iron for strength before receiving a powder-coated Pony-orange finish. Available in a wide variety of sizes and clamping forces, all with full-closing screws.



Ductile Iron

SPECS

Product Number	Max Opening	Reach	Clamping Force
2610	1 in.	1 in.	400 lb.
2615	1 1/2 in.	1 1/2 in.	400 lb.
2620	2 in.	1 in.	400 lb.
2622	2 1/2 in.	1 3/8 in.	600 lb.
2625	2 1/2 in.	2 1/2 in.	600 lb.
2630	3 in.	2 in.	800 lb.
2640	4 in.	3 in.	800 lb.
2650	5 in.	3 1/4 in.	1,000 lb.
2660	6 in.	3 1/2 in.	1,000 lb.
2680	8 in.	4 in.	1,000 lb.



Pony Quick Release Forged C-Clamp

This quick release C-Clamp is a new innovative design. It allows the user to clamp faster than standard C-Clamp by pushing the orange button for quick release to make fast adjustments. Forged steel frame provides more clamping strength and durability. The smoothly cut acme-threaded steel screw is protected with zinc plating for lasting durability.



Rapid Action



Drop-Forged Steel



Zinc Plated



Acme-Thread Screw

SPECS

Product Number	Max Opening	Reach	Clamping Force
206	6 in.	3 1/2 in.	2,500 lb.

Pony Heavy-Duty Drop-Forged C-Clamp

The toughest jobs demand a tougher clamp. Our strongest C-clamps are crafted with heat-treated drop-forged carbon steel frames, copper-coated screws, handles, and swivels for heavy-duty industrial service. The anvil is extra large and broached for flatness, and a black-powder coating provides a smooth finish.



Drop-Forged Steel



Copper Plated



Cold-Drawn ACME Screw



SPECS

Product Number	Max Opening	Clamping Force	Depth of Throat
402-D	2 in.	3,300 lb.	2 in.
403-D	3 in.	3,500 lb.	2 3/8 in.
404-D	4 in.	4,100 lb.	2 3/4 in.
406-D	6 in.	5,400 lb.	3 5/8 in.
408-D	8 in.	5,900 lb.	4 1/2 in.
410-D	10 in.	6,200 lb.	5 3/8 in.
412-D	12 in.	9,300 lb.	5 3/4 in.

Pony carriage C-clamp

Pony's heavy-duty carriage C-clamps are the most universally used general-purpose C-clamps for regular-duty industrial service. Clamp frames are liberally proportioned and heat treated for maximum strength, and ribbed to resist side strain. Longer frame hubs combined with a copper-coated screw with special smoothly cut acme square threads ensure lasting durability. Black-powder-coated castings.



Ductile Iron



Copper Plated



Acme-Thread Screw

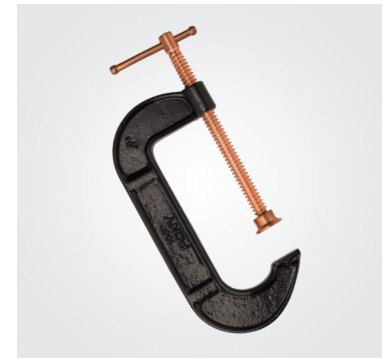

SPECS

Product Number	Max Opening	Clamping Force	Depth of Throat
102	2 1/2 in.	1,400 lb.	1 3/4 in.
103	3 in.	1,800 lb.	1 7/8 in.
104	4 in.	2,200 lb.	2 1/8 in.
105	5 in.	2,200 lb.	2 1/2 in.
106	6 in.	2,200 lb.	2 3/4 in.
108	8 in.	2,400 lb.	3 1/4 in.
110	10 in.	2,400 lb.	3 5/8 in.
112	12 in.	2,400 lb.	3 5/8 in.



HAND AND SPRING CLAMPS

Get complete clamping flexibility with Pony Jorgensen hand and spring clamps. Our classic steel spring clamps are some of the most durable clamps available, and our hand clamps allow for pressure adjustments to meet any woodworking need.



Pony Hand Clamp

Pony hand clamps feature an innovative box-joint design that prevents twisting and keeps the jaws square and straight. Our one-of-a-kind adjustment mechanism allows you to adjust clamping pressure to your desired needs without any additional tools. The soft pivoting jaw pads are ideal for holding delicate work and are riveted to the jaws to ensure they never come off. Soft handles are ergonomically designed for comfortable use.



Patented Feature



Ergonomic Grip

SPECS

Product Number	Max Opening
32225	2 in.
32400	4 in.



Classic Pony Spring Clamp

When you need instant, easy application and removal, turn to the proven durability of classic Pony spring clamps. Throughout the clamp's range of opening, the point of pressure always remains at the lightweight zinc-plated steel jaw tips to ensure they'll hold it together exactly where you need them. Optional poly-vinyl protected handles and jaw tips mean you can use them on metal, wood, plastic, fabric, and beyond. And their contoured handles won't dig into your hands.



Steel Jaws



Zinc Plated

SPECS

Product Number	Protected Handle and Tips	Max Opening	Reach
3201	Without	1 in.	1 1/4 in.
3201-HT	With	1 in.	1 1/4 in.
3202	Without	2 in.	2 in.
3202-HT	With	2 in.	2 in.
3203	Without	3 in.	3 in.
3203-HT	With	3 in.	3 in.
3204-HT	With	4 in.	4 in.

Pony Classic Spring Clamp Pads

Pony steel spring clamp poly vinyl work protecting tips and handles are soft and durable. Provide a resilient protective cushion when clamping wood, metal and plastic surfaces. Vinyl tips prevent marring and vinyl handles for a non-slip grip.

SPECS

Product Number	Fits
7464	#3201, #3201-HT
7465	#3202, #3202-HT
7466	#3203, #3203-HT
7467	#3204, #3204-HT

Pony Adjust-A-Clamp Spring Clamp

Control exactly how much pressure you apply to your projects with the Pony adjust-a-clamp spring clamp. With the turn of a screwdriver, you can change the pressure between one and 50 pounds of clamping force for precise control in light-duty applications. Lightweight plastic jaws deliver comfortable yet durable use, and the soft pivoting jaw pads easily hold irregular-shaped objects and protect workpieces.



Steel Spring



SPECS

Product Number	Opening	Reach
3251	1 in.	1 1/4 in.
3252	2 in.	2 1/8 in.

Pony Plastic Spring Clamp

Pony plastic spring clamp has something for any job requiring frequent clamping and unclamping. Light-weight plastic jaws are designed for comfortable yet durable use. Jaws and handles are glass filled nylon. Spring is heavy-duty tempered steel for maximum strength. And they feature protective pivoting jaw pads to ensure a tight hold on your projects without causing damage.



Steel Spring



SPECS

Product Number	Item Description
3260	Pony 3/4 in Spring Clamp
3261	Pony 1in Spring Clamp
3262	Pony 2in Spring Clamp
3263	Pony 3in Spring Clamp
93260	Pony 14pc Spring Clamp Set - (6) 3/4 in., (4) 1 in., (2) 2 in., & (2) 3 in.

BAND CLAMPS

Keep your next round, rectangular, or irregularly shaped woodworking project together with our range of quality nylon, canvas, and rapid-acting band clamps, made with premium features like self-locking mechanisms and ergonomic grips.





Pony Rapid-Acting Band Clamp

Our Pony rapid-acting band clamp is great for any oddly shaped project. Its plastic jaws ensure a great fit on corners without marring your workpiece. Its ergonomic grip ensures a great fit in your hands.



SPECS

Product Number	Band Length	Band Width	Band Limit
1225	15 ft.	1 in.	1,000 lb.

Classic Pony Band Clamp

The classic Pony band clamp is small, lightweight, and easy to work with, featuring a high-strength band made of nylon webbing, four plastic corners to clamp miter joints, and a positive-hold, self-locking aluminum cam and ratcheting handle for instant release. A black rust-resistant finish is applied to the steel frame.



SPECS

Product Number	Band Length	Band Width	Band Limit
1215	15 ft.	1 in.	1,000 lb.

Pony Canvas Band Clamp

Looking for a band clamp for larger projects? Our heavy-duty Pony canvas band clamp is made with the highest-grade ductile cast iron and features dual self-locking mechanisms, which allow the band to be pulled tight from both sides. The screw and crank handle can be used for final clamping adjustments.

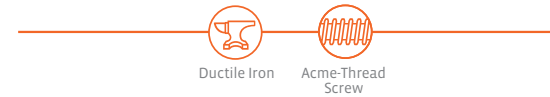

SPECS

Product Number	Band Length	Band Width	Band Limit
6210	10 ft.	2 in.	2,200 lb.
6220	20 ft.	2 in.	2,200 lb.
6230	30 ft.	2 in.	2,200 lb.

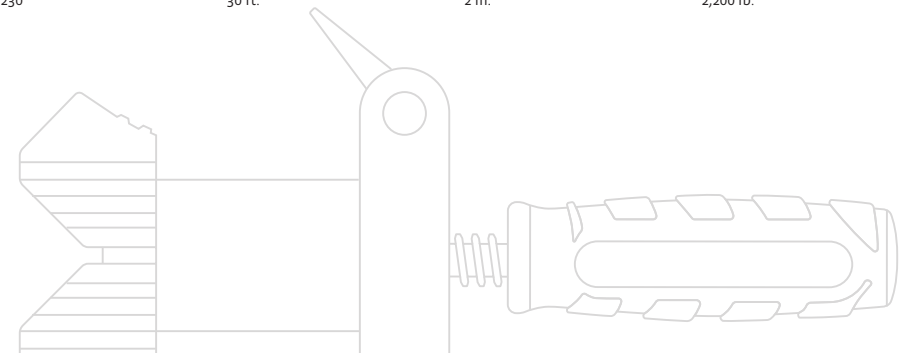



CORNER AND FRAMING CLAMPS

Woodworkers specializing in cabinetry and framing have long trusted Pony Jorgensen clamps. We provide a range of high-quality corner, angle, and framing clamps that make it easier to create a perfect miter, butt, or T-joint.



Pony Corner and Splicing Clamp

Easily clamp miter joints and butt joints with Pony corner and splicing clamps. The die-cast aluminum frame and sliding jaws hold workpieces up to three inches wide and leave joints fully exposed for miter correction, doweling, gluing, or nailing. Plated cold-drawn steel screws with smoothly rolled threads ensure durability and reliability. Two countersunk holes allow you to mount the clamps to benchtops. Available in 90-degree or adjustable-angle variations.



Aluminum Frame



Cold-Drawn Screw

SPECS

Product Number	Description
9133	Pony 3 in. corner and splicing clamp adjustable to any angle 0° to 180°
9166	Pony 3 in. 90° corner clamp

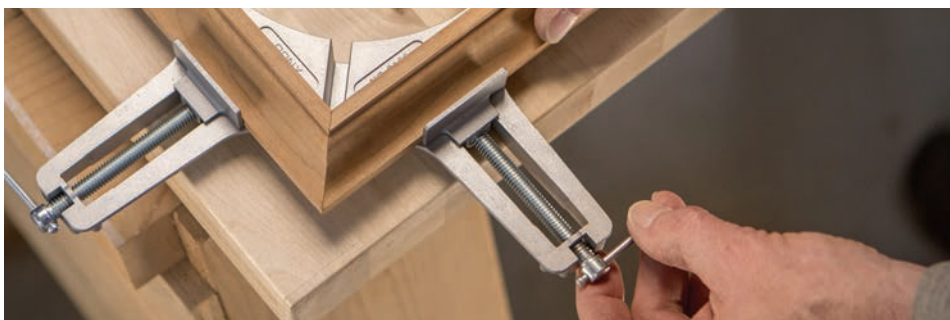

Pony Angle Clamp with Table Clamps

The Pony angle clamp with table clamps is perfect for framing and cabinet assembly. Its plastic-coated die-cast jaws won't damage your workpiece surfaces, and the rear jaw swivels allow for easy adjustments, depending on material thickness. Generous clearance is provided for gluing, doweling, or stapling material, and acme-threaded screws ensure maximum strength. Use with confidence for miters and butt joints up to two inches, and for T-joints up to 1 1/8 inches.



Acme-Thread Screw

SPECS

Product Number	Description
9180	Angle clamp with 2 table clamps

Pony four-corner framing clamp

The complete Pony four-corner framing clamp kit is ideal for fine framing, and it includes plated-steel threaded rods, lightweight plastic corners, and durable plated-zinc alloy thumbnuts. Adjust the size for any square or rectangular project.



Zinc Plated

SPECS

Product Number	Size
9424	24 in.
9448	48 in.



Pony Self-Squaring Frame Clamp

Pony's self-squaring framing clamp is ideal for picture frame assembly. It clamps all four corners of a frame at the same time for consistent results. Reversible jaws allow for use with both small and large frames, from 5 x 7 in. to 26 x 30 in. Easily fold it up after you're done for compact storage.



Aluminum Rails

SPECS

Product Number	Description
88094	Pony self-squaring frame clamp

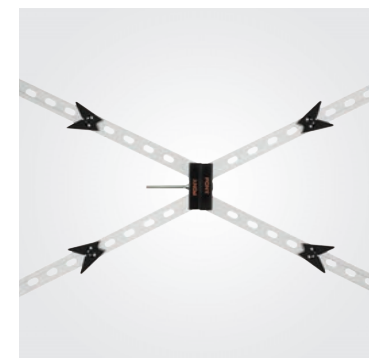

Pony 4PK Quick Release Corner Clamp

This quick release corner clamp is lightweight and easy for single-handed operation. It is good for fast and simple fixing of boards and frames at an angle of 90 degree. The adjustable jaw design allows it fit for boards with a thickness of 3/16"-7/8" for 90 degree corner and T-joints, even with different board thicknesses. The strong flexible spring helps keep boards sturdy in place when screwing or gluing them together. It is a perfect tool for small wood working or wooden DIY project, such as to build wooden boxes, picture frames, bookshelves, dresser drawers, etc.



Rapid Action

SPECS

Product Number	Description
9122	4PK Quick Release Corner Clamp





SPECIALTY CLAMPS

When a traditional clamp just won't cut it, grab a high-quality Pony Jorgensen specialty clamp. Choose among iconic Jorgensen handscrew clamps, hold-down clamps, cabinet claws, press screws, gear clamps, and edging clamps.



Classic Jorgensen Adjustable Handscrew

Every Jorgensen handscrew we make is crafted to ensure maximum strength and durability. Seasoned, straight-grain hard maple wood jaws marry with cold-drawn steel spindles and nuts with special double-lead threads. Together they create a handscrew clamp that holds tightly over broad areas, providing greater reach and a wider distribution of pressure than other clamps. The angle between the jaws can be adjusted to fit the work, allowing them to hold odd shapes easily. Our handscrew clamps are easy to apply and remove quickly, and provide protection against marring of finished surfaces. Traditional seasoned hardwood handles are designed for comfort now and for years to come.



SPECS

Product Number	Jaw Length	Max Opening	Reach
3/0	6 in.	3 in.	2 3/4 in.
0	8 in.	4 1/2 in.	3 7/8 in.
1	10 in.	6 in.	5 in.
2	12 in.	8 in.	6 in.

Pony Cabinet Claw™

Complete your cabinetry projects in a fraction of the time with Pony cabinet claws. This unique and patented tool combines the various steps of face-frame cabinet installation into one easy process. The high-quality aluminum claws and alignment plate have protective pads to cushion and protect cabinetry.



SPECS

Product Number	Description
8510	Pony cabinet claw (2 pack)
8511	Pony cabinet claw

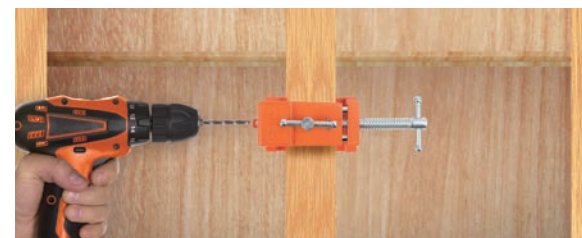

TIME-SAVING

TOOL FOR PROFESSIONAL CABINET INSTALLATION



Pony Three-Way Edging Clamp

When you need to repair molding, decorative trim, countertop edging, or veneer strips, trust the Pony three-way edging clamp. This drop-forged steel orange-powder-coated clamp provides a convenient, practical method for applying right-angle pressure to the edge or side of any workpiece.



SPECS

Product Number	Max Opening	Clamping Force	Depth of Throat
3325	2 1/4 in.	800 lb.	2 1/2 in.





Pony Hold-Down Clamp

Pony hold-down clamps offer the advantage of benchtop and machine-table in-surface in-clamping. They are designed to rotate a full 360 degrees around the holding bolt and can be used on any wood or metal surface. Our heavy-duty hold-down clamp is designed to be mounted anywhere a T-slot or machine bolt can be installed, and its unique square-head screw can be tightened with a wrench for a secure hold.



Ductile Iron

Square-Head
Screw

MEDIUM DUTY

Product Number	Opening	Throat Depth	Clamping Force
1623	3 in.	1 3/4 in.	2,000 lb.
1623-BA (bolt assembly)	-	-	-

HEAVY DUTY

Product Number	Opening	Throat Depth	Clamping Force
1834	4 in.	2 1/2 in.	6,000lb.



Pony Bench Hold-Down Clamp

The Pony bench hold-down clamp is a versatile, easy-to-use clamp made for holding work in place on benchtops, and it's made of solid iron with a black baked-enamel finish. Simply tap it into a predrilled hole in your benchtop.



Ductile Iron

SPECS

Product Number	Length	Reach	Predrilled Hole
1708	8 in.	4 in.	11/16 in.
1716	16 in.	8 in.	13/16 in.

Pony Press Screws

Pony heavy-duty press screws are ideal for making veneering frames and are especially useful for deep-reach surface clamping. The large removable cast-iron swivels make installation a breeze, and the threaded bushings fit easily into a one-inch hole. 11/16-inch diameter cold-drawn steel screws with special smoothly cut acme threads provide a tight hold.



Ductile Iron

Cold-Drawn
Acme Screw

SPECS

Product Number	Length	Screw Diameter	Swivel Face Size	Handle
6709	9 in.	11/16 in.	1 3/8 x 1 5/8 in.	Crank
6712	12 in.	11/16 in.	1 3/8 x 1 5/8 in.	Crank
6718	18 in.	11/16 in.	1 3/8 x 1 5/8 in.	Crank

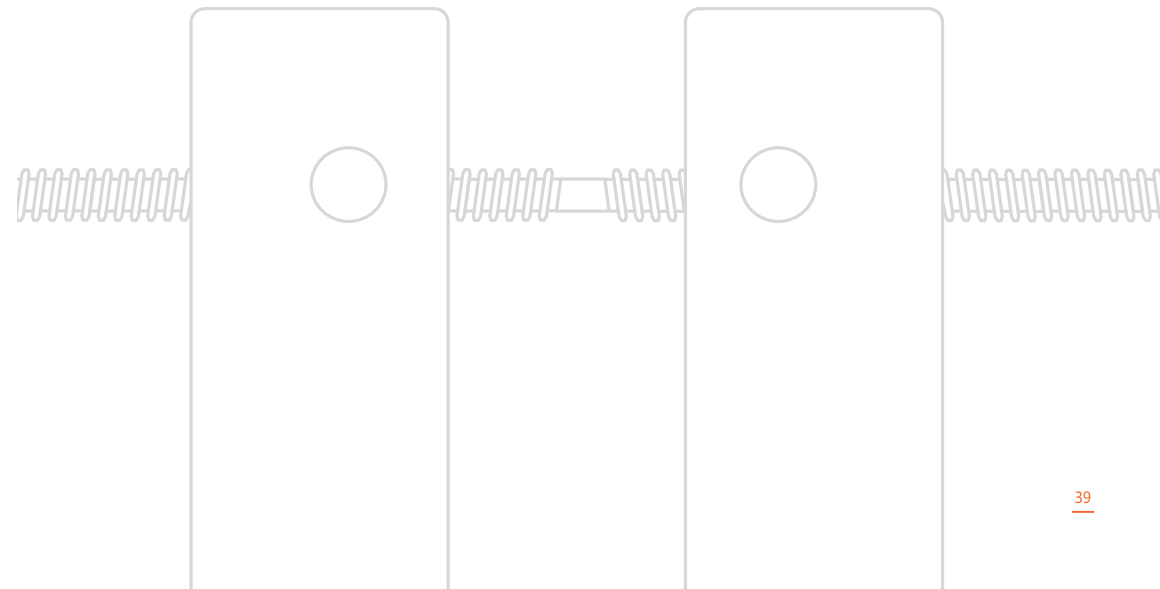



VICES

Pony Jorgensen offers a wide range of vises to meet the needs of uncompromising woodworkers, including light-duty, heavy-duty, bench, and drill press vises for home, shop, and professional use.

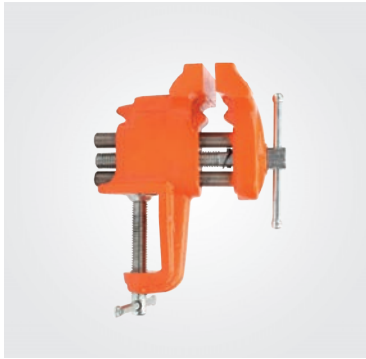

Pony Light-Duty Clamp-On Vise

The Pony light-duty clamp-on vise is ideal for light-duty home, shop, and professional use, featuring plated-steel double guide bars for smooth operation. It mounts easily and securely on edges up to two inches thick, and its portable, lightweight design lets you take it anywhere.



Cast Iron

SPECS

Product Number	Jaw Width	Max Opening	Throat Depth	Pipe Vise Capacity
13025	3 in.	2 1/2 in.	1 1/2 in.	3/8 in. to 1 3/4 in.

Pony Heavy-Duty Workshop Bench Vise

This Pony workshop bench vise provides heavy-duty performance, featuring a swivel base with a lock-down nut, hardened-steel serrated jaw faces, a large ground and polished anvil, permanent pipe jaws, and large forming horns.



Steel Jaws



Acme-Thread Screw

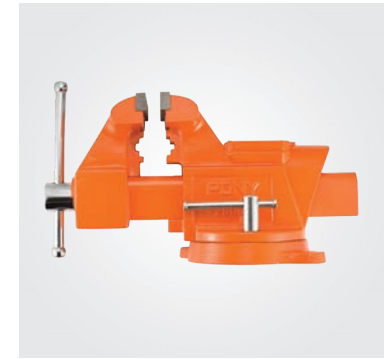

SPECS

Product Number	Jaw Width	Max Opening	Throat Depth
29040	4 in.	3 1/2 in.	2 5/8 in.
29050	5 in.	4 in.	3 1/2 in.
29060	6 in.	5 in.	3 3/4 in.



Pony Light-Duty Bench Vise with Swivel Base

Consider the Pony light-duty bench vise with swivel base for your light-duty home, shop, and professional use. These vises feature rugged strength you'd usually have to spend more for, with square four-hole swivel bases, sturdy steel jaw faces, ground and polished anvils, permanent pipe jaws, forming horns, and a minimum of 180 degrees of swivel.



Steel Jaws



Acme-Thread Screw

SPECS

Product Number	Jaw Width	Max Opening	Throat Depth	Pipe Vise Capacity
23530	3 1/2 in.	3 in.	2 in.	5/8 in. to 1 3/8 in.
24545	4 1/2 in.	3 in.	2 5/8 in.	5/8 in. to 1 7/8 in.

Pony Multipurpose Vise

The Pony multipurpose vise features rugged strength usually found only in more expensive vises. Ductile iron castings and bright-plated steel hardware allow for extreme durability, and its jaws with countersunk holes rotate and swivel a full 360 degrees.



Ductile Iron



Acme-Thread Screw



SPECS

Product Number	Jaw Width	Max Opening	Throat Depth	Pipe Vise Capacity
29055	5 in.	5 in.	2 5/8 in.	5/8 in. to 2 1/2 in.



Pony Quick-Release Vice

The Pony quick-release vise has been designed to handle the toughest heavy-duty applications. Its 360-degree swivel base and dual locks combine with a unique quick-release mechanism that lets you make fast adjustments without having to screw the handle in and out, giving you the ultimate in benchtop performance.

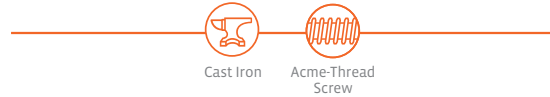

SPECS

Product Number	Jaw Width	Max Opening	Throat Depth	Pipe Vise Capacity
30105	5 in.	7 in.	3 in.	1 in. to 2 3/8 in.

Pony Light-Duty Woodworker's Vice

This lightweight Pony woodworker's vise is designed for light-duty home and shop use. An acme-threaded main screw and plated-steel twin guide bars allow for smooth operation, and countersunk holes in the jaws are perfect for wood-facing attachments.

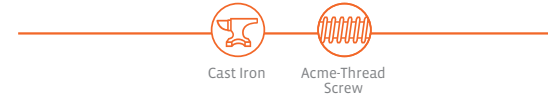

SPECS

Product Number	Jaw Width	Max Opening	Throat Depth
26545	6 1/2 in.	4 1/2 in.	2 in.



Pony Drill Press Vice

Our Pony drill press vise will feel right at home in your personal workshop. A four-inch opening capacity allows you to clamp a wide range of projects for safe drilling, and the slots along each side let you easily mount it to any drill press.

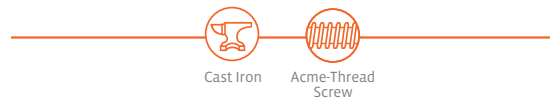

SPECS

Product Number	Jaw Width	Max Opening
29058	4 in.	4 in.

Pony Woodworker's Vice

The standard Pony woodworker's vise is fit for both light- and medium-duty applications, featuring double guide bars, continuous screw action, a solid steel dog, and countersunk jaw holes for wood-facing attachments.

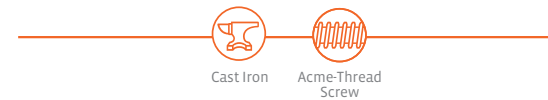

SPECS

Product Number	Jaw Width	Max Opening	Throat Depth
27091	7 in.	8 in.	3 in.

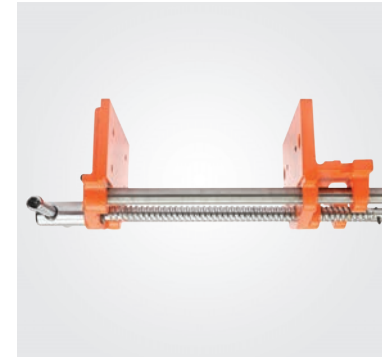



Jorgensen Professional Rapid-Acting Woodworker's Vise

The mother of all woodworking vises has arrived. Jorgensen's rapid-acting woodworker's vise sets the bar for quality and performance. Crafted with the finest materials, including a specially cut acme-threaded main screw, cold-drawn steel twin guide bars, and steel handles. A standard quick-action release allows for fast opening and closing, and a solid-steel dog in the front jaw allows for even oversized workpieces to be held securely. The machined, toed-in jaws provide a solid grip, and countersunk jaw holes allow for optional wood facings. This versatile tool also includes an extra nut that allows for conversion to a continuous-acting vise.



Ductile Iron



Acme-Thread Screw

SPECS

Product Number	Jaw Size	Max Opening	Weight
40709	4 x 7 in.	9 in.	36 lb.
41012	4 x 10 in.	12 in.	39 lb.



Pony Bench Dog

The Pony bench dog allows you to hold or secure your work on your benchtop when used with a woodworker's vise front jaw steel dog. It fits into any 3/4-inch benchtop hole.



Solid Steel

SPECS

Product Number	Description
1722	Bench dog

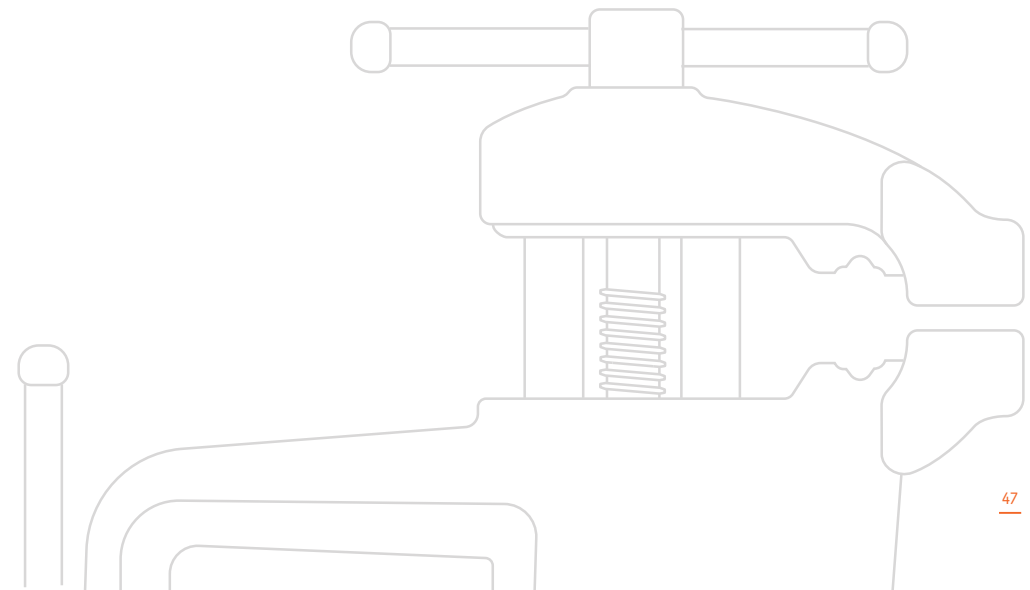



WORK SUPPORT

Meet the uncompromising demands of professionals and DIYers alike with Pony Jorgensen's worktables and sawhorses. Versatile and sturdy, these worktables and sawhorses set up in seconds and make an ideal addition to any jobsite.



Pony E-Z Clamp™ Heavy Duty Folding Worktable

Meet your new favorite work horse. Pony's E-Z Clamp™ Heavy Duty Folding Worktable features quick clamps and holding pegs that can support up to 500 lb. as a table and up to 3,000 lb. as a sawhorse. The convenient 2-in-1 worktable and sawhorse makes for quick and easy conversion for tackling more projects. The bar clamps can fasten directly to the worktable/sawhorse, as well as hold items vertically or horizontally for greater flexibility while you work. Thanks to its hassle-free breakdown and folding mechanism, moving from job to job or from the basement to the garage is no problem. In addition, the 6 positions height-adjusting feature allows you to adapt to any size project, enabling you to work at different levels. A built-in shelf provides storage for tools and materials, saving space and keeping everything close by.

SPECS

Product Number	Height	Clamping Span	Tabletop
60p	35 in.	29 1/2 in.	31X25 in.
60(worktable only)	35 in.	29 1/2 in.	31X25 in.

Pony E-Z Clamp™ Heavy Duty Folding Worktable works with the current Jorgensen®, Irwin®, Bessey® & DeWalt® medium duty trigger clamps

- May subject to each brand's spec changes
- All brands are registered trademarks of their respective owners



Pony 2-Piece Clamping Sawhorses

Quickly set up and break down Pony's 2-piece clamping sawhorses. These versatile and sturdy sawhorses support up to 600 lb. each and up to 1,200 lb. together, making it an ideal addition to your workshop or jobsite. The bar clamps and angle adapter can fasten directly to the sawhorse, as well as hold items vertically or horizontally for greater flexibility while you work. A built-in shelf provides storage for tools and materials, saving space and keeping everything close by.

Set includes

- (2) 12 in. light-duty E-Z HOLD bar clamps
- (2) bench dogs
- (1) angle clamp adapter

SPECS

Product Number	Height	Clamping Span	Max Loading
60400	32 in.	26 in.	1,200lb.





HAND SAWS

Whether you are a diyer or a professional like a craftsman or a carpenter, a hand saw is an essential cutting tool you should have in your toolbox or workshop when doing woodworking or carpentry tasks. Jorgensen offers a wide range of sizes and types of handsaws for various applications in professional trades or simply at home and in the garden.



The All New Jorgensen Sabertooth Professional Pull Saws are a cut above the competition. Made of premium, heat treated and electroless nickel (EN) plated SK5 Japanese steel, cutting has never been faster or smoother.

Premium Steel
Premium SK5 Japanese steel for great durability.

Advanced Heat Treatment
Special induction hardened teeth stay sharper for longer than the competition.

Electroless Nickel Plated Blades
Electroless Nickel (EN) plating provides excellent wear resistance and hardness, as well as corrosion protection. The coating also creates a smooth surface, reducing friction during cutting and preventing wood dust adhesion.

Precision Cuts
Extra thin 0.3mm blade is ideal for precision cuts and narrow kerfs.

Quick Blade Changes

Tool-less blade change and fast folding designs.

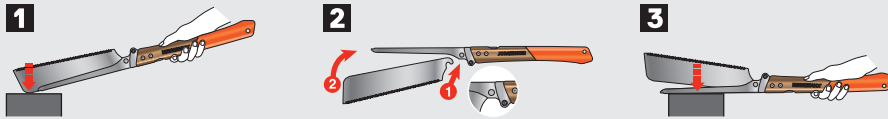

Jorgensen Sabertooth® Pro Folding Dovetail Pull Saw DOZUKI

Ideal for fine cutting dovetails and tenons precisely, crafting musical instruments and furniture restoration.



SPECS

Product Number	Blade Length	Pitch	Blade Thickness	Kerf
70620	9.5 in. (240mm)	1.2mm (21TPI)	0.3mm	0.45mm
70622	6 in. (150mm)	1.2mm (21TPI)	0.3mm	0.45mm

Jorgensen Sabertooth® Pro Dovetail Pull Saw DOZUKI

Ideal for fine cutting dovetails and tenons precisely, crafting musical instruments and furniture restoration.

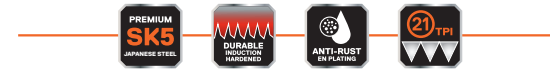

SPECS

Product Number	Blade Length	Pitch	Blade Thickness	Kerf
70680	9.5 in. (240mm)	1.2mm (21TPI)	0.3mm	0.45mm

Jorgensen Pro Dovetail Pull Saw Blade

SPECS

Product Number	Size	Fits
70621	9.5 in. (240mm)	#70620, #70680
70623	6 in. (150mm)	#70622





Jorgensen Sabertooth® Pro Double Edge Pull Saw RYOBA

Ideal for general purpose carpentry and joinery, cutting sawn wood in all directions.



SPECS

Product Number	Blade Length	Pitch	Blade Thickness	Kerf
70626	10 in. (250mm)	1.4mm (18TPI)	0.5mm	0.75mm



Jorgensen Pro Double Edge Pull Saw Blade

SPECS

Product Number	Size	Fits
70627	10 in. (250mm)	#70626

Jorgensen Sabertooth® Pro Double Edge Flush Cut Saw

Ideal for cutting dowels, pegs, tenons or anything right up against another surface.

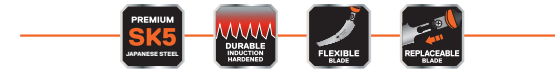

SPECS

Product Number	Blade Length	Pitch	Blade Thickness	Kerf
70628	5 in. (125mm)	1.4mm (18TPI) & 1.0mm (25TPI)	0.4mm	0.4mm

Jorgensen Pro Double Edge Flush Cut Saw Blade

SPECS

Product Number	Size	Fits
70629	5 in. (125mm)	#70628



7-12 TPI

RIP CUT



18 TPI

CROSS CUT



FLUSH CUTTING DOWELS



Jorgensen Handsaw

Jorgensen's Sabertooth® low friction black coated coarse handsaw designed with a heavy duty aluminum frame composite handle for added strength and durability. The black coating reduces friction to prevent drag while cutting. Triple-ground teeth enables fast and efficient cutting on both the push and pull stroke. The induction hardened blade teeth makes for long-lasting sharpness and is the ideal choice for long-term use. Built-in 45° and 90° angle markings for guided cutting.



SPECS

Product Number	Blade Length	Teeth Per Inch	Blade Thickness
70610	15 in. (380mm)	8	0.85 mm
70614	20 in. (508mm)	11	0.85 mm



Jorgensen Coping Saw

The Jorgensen coping saw is used for cutting and shaping intricate and irregular shapes with precise control. The high speed steel blade can be turned 360° to saw in any direction. The heavy duty steel frame ensures durability. The extra-deep 6-1/4 in. clearance is designed for angled and curved cuts in hard to reach areas.



SPECS

Product Number	Blade Length	Teeth Per Inch
70670	6 1/2 in. (165 mm)	15

Jorgensen 5PC Coping Saw Blades

The Jorgensen 6.5 in. coping saw blades assortment pack fits all standard coping saws. The coping saw blades are designed for precise sawing of wood, plastic, copper and other soft metals. Each pack contains 2pc 20 TPI fine, 2pc 15TPI medium, and 1pc 10TPI coarse toothed blades.

SPECS

Product Number	Blade Length
70675	6 1/2 in. (165 mm)

Jorgensen 6 in. Bi-Metal Jab Saw

Saw quickly and safely with Jorgensen's 6-inch jab saw. The unique bi-metal blade design offers three times the cutting life of a standard knife. Complete with black coating enabling low friction and less drag, the jab saw also features a sharpened point with bevel for easy puncture of MDF, PVC, plaster-board, plywood, and thin paneling.



SPECS

Product Number	Blade Length	Teeth Per Inch	Blade Thickness
70650	6 in. (152mm)	8	1.6 mm



Jorgensen Plastic Miter Box with Saw

The Jorgensen durable and practical high-impact plastic mitre box is designed for light duty projects. It has fixed slots for guided cutting at 45°, 90° and 45° face mitre cuts. The extended front lip design serves to steady the box against workbench edge. There are also countersunk mounting holes for fastening to a workbench. Base openings for woodchips and sawdust. This mitre box comes complete with a 14 in. fine tooth saw.

SPECS

Product Number	Blade Length	Teeth Per Inch	Blade Thickness
60112 Plastic Miter Box	-	-	-
60115 Plastic Miter Box with Saw	14 in. (350mm)	12	0.7 mm



Jorgensen Clamping Miter Saw

The Jorgensen clamping miter box with saw is designed to easily make precision cuts in wood. Metal base can be easily assembled on the Pony worktable by bench dogs. It features simple angle adjustment for most applications, 6 pre-set angles 45°, 54°, 60°, 67.5°, 75° and 90° – both right and left. The box comes with a 17 in. saw that has induction-hardened teeth for a longer cutting life and a slip-resistant grip for comfort and control.



SPECS

Product Number	Blade Length	Teeth Per Inch
60120 Clamping Miter Saw	17 in. (430mm)	14
60121 2PK Replacement Blade	17 in. (430mm)	14, 18





PLANES

Unleash your creativity and precision with Jorgensen's premium selection of superior-quality woodworking hand planes.



Jorgensen Mini Block Plane

Jorgensen's Mini Block Plane is small enough to be used in one hand and is designed for model making, instrument building, sculpting and other detail-oriented miniature work. It features a captive nut blade adjuster for precisely controlled depth of cut. The 25° bevelled blade is seated at 20° within the plane, giving an effective cutting angle of 45°.

Replacement Blade for Mini Block Plane



• These genuine replacement blades are designed to fit Jorgensen planes. Heavy gauge (3 mm) O1 steel iron is hardened and tempered to Rockwell 60-64, provides excellent edge retention and solid chatter-free cutting.

SPECS

Product Number	Length	Width	Blade Width	Weight
70700	3 1/2 in. (88mm)	1 1/4 in. (32mm)	7/8 in. (22.2mm)	7oz.



Jorgensen No. 60-1/2 Low Angle Adjustable Mouth Block Plane

Based on the Stanley 60 1/2, this is one of the most popular block plane. 1/8 in. thick O1 steel blade provides excellent edge retention. The adjustable mouth can close up to the blade when taking the finest of shavings or open up when taking coarse shavings. The blade is adjusted with a captive adjuster nut for precise control with minimal backlash. The blade is flat ground at 25° and sits bevel up in the body at 12° makes a 37° low cutting angle out of the box for planing end grain and general purpose work.

Replacement Blade for No. 60-1/2 Low Angle Adjustable Mouth Block Plane



• These genuine replacement blades are designed to fit Jorgensen planes. Heavy gauge (3 mm) O1 steel iron is hardened and tempered to Rockwell 60-64, provides excellent edge retention and solid chatter-free cutting.

SPECS

Product Number	Length	Width	Blade Width	Weight
70710	6 1/4 in. (160mm)	1 3/4 in. (44.5mm)	1 3/8 in. (35mm)	1.48 lb.

Jorgensen No.4 Smooth Plane

Based on the Classic Stanley Bedrock design, this is the standard-size smoothing plane. Blade is made from extra-thick 1/8 in. O1 steel for excellent edge retention and solid chatter-free cutting. The blade is ground with a 25° bevel and bedded at 45° with the bevel down. The hardwood front knob and rear handle provide excellent control and comfort. The Jorgensen No.4 smooth plane is ideal for general smoothing, finish work and trimming parts.

Replacement Blade for No.4 Smooth & No.5 Jack Plane



• These genuine replacement blades are designed to fit Jorgensen planes. Heavy gauge (3 mm) O1 steel iron is hardened and tempered to Rockwell 60-64, provides excellent edge retention and solid chatter-free cutting.

SPECS

Product Number	Length	Width	Blade Width	Weight
70730	10 in. (255mm)	2 1/2 in. (64mm)	2 in. (50.8mm)	4.28 lb.



Jorgensen No.5 Jack Plane

The Jorgensen's No.5 Jack Plane has similar specifications to the No.4 Smooth Plane in many respects, but it is a bit longer. The 14 in. length makes the No. 5 Plane useful for stock removal, smoothing, shooting miters, and jointing smaller work. Based on the classic Stanley Bedrock design, the fully machined adjustable frog made adjustments to the mouth quick and easy without the need to remove the blade and cap. The lightly finished hardwood knob and handle provide comfort and control.

Replacement Blade for No.4 Smooth & No.5 Jack Plane



• These genuine replacement blades are designed to fit Jorgensen planes. Heavy gauge (3 mm) O1 steel iron is hardened and tempered to Rockwell 60-64, provides excellent edge retention and solid chatter-free cutting.

SPECS

Product Number	Length	Width	Blade Width	Weight
70735	14 in. (355mm)	2 1/2 in. (63.5mm)	2 in. (50.8mm)	5.16 lb.





Jorgensen Corner Easing Plane

The Jorgensen corner easing plane can make quick work of edge relief. Made from high-grade die-cast aluminum alloy and precisely machined, it's durable and provides great corner finish results. The large thumbwheel on the product is easily and precision adjusted the cut depth. Hardened O1 steel blade is sharp and durable. 45° chamfer blade and 1/8-in, 3/16-in, 1/4-in radius blades can be cut out different edge shapes



SPECS

Product Number	Description
70748	Corner Easing Plane w/ 45° Chamfer Blade and 3PK Radius Blade 1/8 in., 3/16 in., 1/4 in.

Jorgensen 10 in. Rasp Plane

The 10 in. Jorgensen rasp plane series are manufactured with die-cast alloy body. It is light weight and durable. The blade is fine-polished, sharp and durable. It features a multi-position handle for different work condition use. Also the replaceable blade is available. Ideal for end-grain work, sheet-rocking and smoothing edges of laminates.



• Replacement Blade for 10in. Rasp Plane 70750 & 70755

70758

SPECS

Product Number	Description
70755	10 in. Rasp Plane with 2-position Handle
70750	10 in. Rasp Plane, Fixed Handle

Jorgensen 6 In. Pocket Rasp Plane

The Jorgensen rasp plane series are manufactured with die-cast alloy body. It is light weight and durable. The blade is fine-polished, sharp and durable. The 6 in. rasp is designed for one-handed use. Also the replaceable blade is available. Ideal for end-grain work, sheet-rocking and smoothing edges of laminates.



• Replacement Blade for 6in. Pocket Rasp Plane

70768

SPECS

Product Number	Description
70760	Pocket Rasp Plane

Jorgensen Mini Rasp Plane

The Jorgensen mini rasp plane has a carbon steel blade mounted on a compact and lightweight ABS molded plastic body. The curved blade is interchangeable by simply clicking in. It works on the pull stroke for efficient stock removal.



• Replacement Blade for Mini Rasp Plane

70765

SPECS

Product Number	Description
70764	Mini Rasp Plane



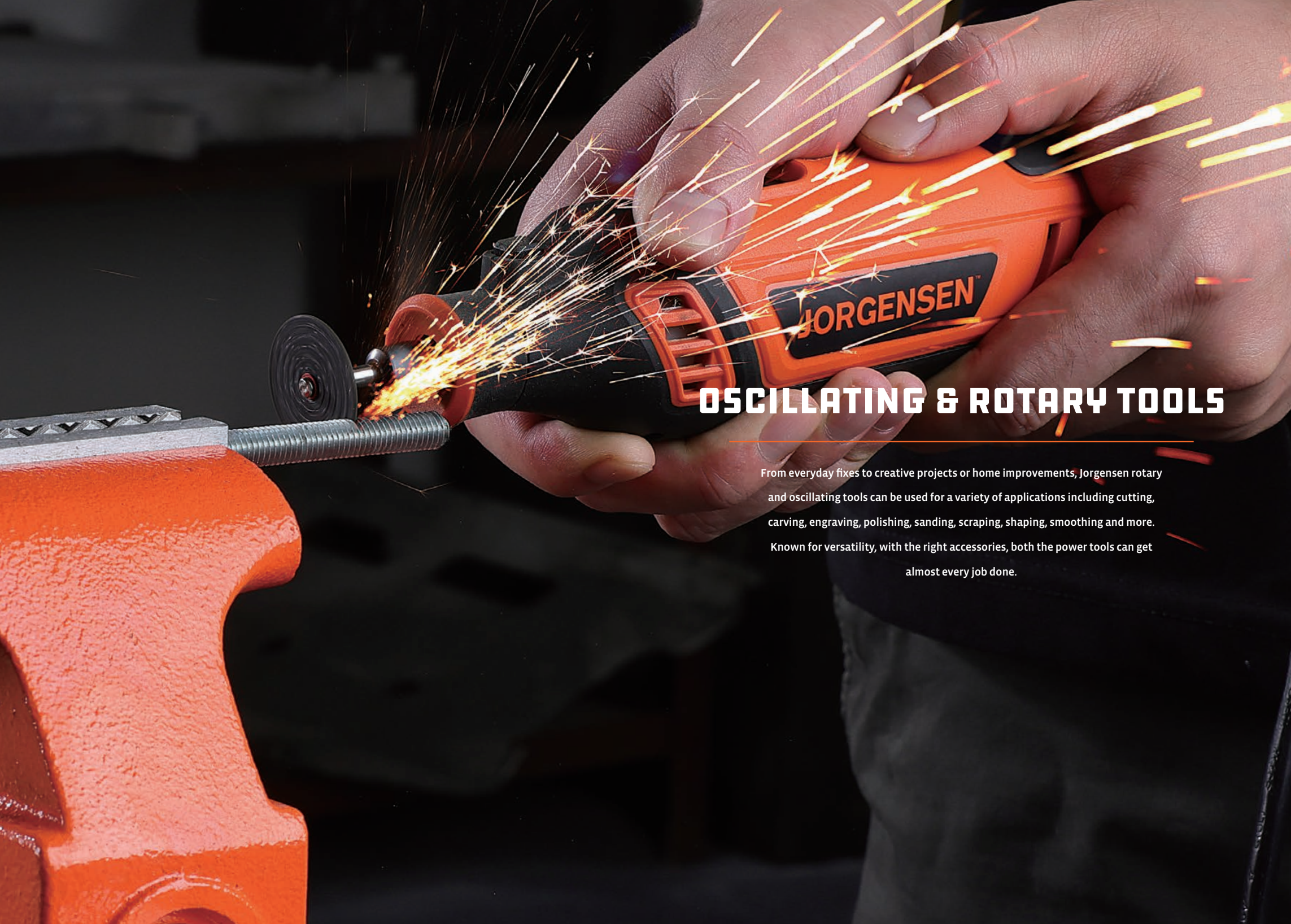

OSCILLATING & ROTARY TOOLS

From everyday fixes to creative projects or home improvements, Jorgensen rotary and oscillating tools can be used for a variety of applications including cutting, carving, engraving, polishing, sanding, scraping, shaping, smoothing and more.

Known for versatility, with the right accessories, both the power tools can get almost every job done.



Jorgensen 4.0 Amp Oscillating Multi-tool Kit

This Oscillating Multi-tool Kit features a powerful 500 watt motor that maintains constant power and speed at all levels to easily tackle cutting and sanding jobs. The 9 Piece Accessory Kit includes a titanium coated fine tooth blade, a half circle bi metal flush cut blade, and a multipurpose sanding kit with 80, 120, and 220 grit sandpaper. Best of all, the quick-change accessory system allows for blades and attachments to be changed quickly without wrenches, saving valuable time and effort on the job.



SPECS

Product Number	Voltage & Frequency	Motor Power	No Load Speed	Oscillating Angle
70800	120V/60Hz	4.0 A	8,000-16,000 RPM	5°

Jorgensen 1.6 Amp Rotary Tool Kit

Expand your Jorgensen tool system with the 1.6-Amp Rotary Tool and 51-Piece Accessory Kit. The powerful 1.6-amp high-performance motor delivers maximum performance even in the most demanding applications. This rotary tool features six variable-speed settings ranging from 10,000 RPM to 35,000 RPM, giving users optimal performance and control with various materials. The included 51-Piece Accessory Kit provides the ability to complete a wide variety of precision-based applications, like intricate wood-working, grinding, polishing, carving, and other craft projects. Best of all, the accessory case included with this rotary tool offers a convenient way to stay organized and keeps your bits close by for quick and easy changes.



SPECS

Product Number	Voltage & Frequency	Motor Power	No Load Speed
70900	120V/60Hz	1.6 A	10,000-35,000 RPM



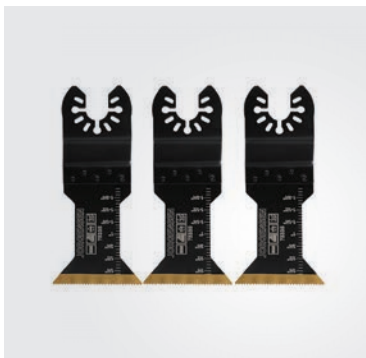

Titanium-Coated Bi-Metal Cutting Blade Pack

Jorgensen's Titanium-Coated Bi-metal Cutting Blade Pack features a three-pack of 1 3/4 in. blades for easy use to complete all your projects. These titanium-coated cutting blades have a universal-fit open-back connector for use on most major brands of oscillating tools. These blades are ideal for wood, wood with nails, PVC, drywall, and soft metal. The solid and durable bi-metal blades with titanium-nitride coating along the tooth strip to prolong blade life by reducing heat and increasing hardness.



Universal Fit

SPECS

Product Number	Width	Cutting Depth
70821	1 3/4 in. (44mm)	2 in. (50mm)

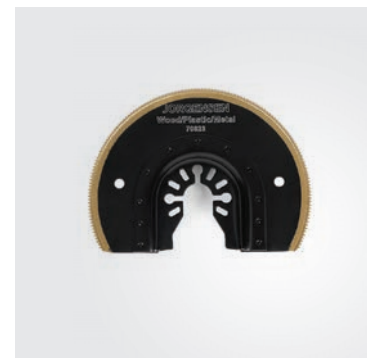

Titanium-Coated Bi-Metal Flush-Cut Blade

Jorgensen's Titanium-Coated Flush-Cut Blade is ideal for cutting wood containing nails – as well as soft metal, PVC, drywall, and more – with your oscillating tool. The large 3 7/16 in. bi-metal blade with titanium-nitride coating along the tooth strip prolongs blade life by reducing heat and increasing hardness. The unique blade shape allows users to perform flush cuts in a variety of applications. And best of all, the Titanium-Coated Flush-Cut blades come with a universal-fit open-back connector for use on most major brands of oscillating tools.



Universal Fit

SPECS

Product Number	Width	Cutting Depth
70823	3 7/16 in. (87mm)	3/4 in. (19mm)



Titanium-Coated Bi-Metal Cutting Blade Pack

Jorgensen's Titanium-Coated Bi-metal Blade Pack features a two-pack of 1 1/4 in. blades for convenient use to complete your cutting projects. These solid and durable bi-metal blades are made with titanium-nitride coating along the tooth strip to prolong blade life by reducing heat and increasing hardness. The wide 1 1/4 in. blade easily removes material quickly and effectively. The Titanium-Coated Bi-metal Blade have a universal-fit open-back connector for use on most major brands of oscillating tools.



Universal Fit

SPECS

Product Number	Width	Cutting Depth
70822	1 1/4 in. (32mm)	2 in. (50mm)



Bi-metal Oscillating Blades Pack

Jorgensen's Bi-metal Oscillating Blades come in a convenient three-pack that make the perfect attachment for cutting wood, wood with nails, PVC, and so much more. This bi-metal blade is durably made for long-lasting use on your cutting jobs, and its unique 1 5/16 in. blade makes removing material a breeze. Best of all, these blades come with a universal-fit open-back connector for use on most major brands of oscillating tools.



Universal Fit

SPECS

Product Number	Width	Cutting Depth
70824	1 5/16 in. (34mm)	2 in. (50mm)



Japanese Tooth Blade Pack

Introducing Jorgensen's Japanese Tooth Blade Pack. Our newest blades feature an open-back design, allowing for a universal fit on nearly all oscillating multi-tools. The Japanese Tooth Blade Pack is ideal for fast cutting of hardwood and softwood quickly, efficiently, and accurately. Additionally, the extended depth of the Japanese tooth blades is perfect for deep plunge cuts and for applications in need of that extra reach. These tough and durable blades are made from high-carbon steel and come in a handy two-pack of 1 1/4 in. blades so you can be sure to get the job done.



Universal Fit

SPECS

Product Number	Width	Cutting Depth
70825	1 1/4 in. (32mm)	2 11/16 in. (68mm)



Multipurpose Sanding Kit

Jorgensen's Multipurpose Sanding Kit is designed to deliver exceptional results on wood surfaces. This seven-piece multipurpose sanding kit features one 3 1/8 in. trangle sanding pad and six sheets of sandpaper in 80, 120, and 220 grit. The sanding pad & paper utilizes hook and loop technology for fast and secure paper changes. The Multipurpose Sanding Kit is ideal for paint removal and wood sanding, helping you gain access in hard to reach areas. This kit is conveniently designed to have a universal-fit open-back connector for use on most major brands of oscillating tools.



Universal Fit

SPECS

Product Number	Size
70827	3 1/8 in. (80mm) trangle



Oscillating Assortment Blade Pack

Jorgensen's Oscillating Assortment Blade Pack comes with three blades that are ideal for fast cutting hardwood and softwood, metal, wood with nails, PVC, and drywall. The three-pack assortment of blades features a durable high-carbon steel blade that's perfect for cutting hardwood and softwood quickly, a bi-metal blade that's ideal for cutting wood with nails, and a strong titanium-coated blade that can be used to cut wood and metal. The universal-fit open-back connector fits most oscillating multi-tools and requires no adapter.



Universal Fit

SPECS

Product Number	Width	Cutting Depth
70826	1 5/16 in. (34mm)	1 9/16 in. (40mm)
	1 5/16 in. (34mm)	1 9/16 in. (40mm)
	1 7/64 in. (28mm)	1 9/16 in. (40mm)



General Purpose Scraping Kit

Jorgensen's General Purpose Scraping Kit delivers high-performance removal of soft and hard adhesives. This scraping kit is ideal for quick and efficient removal of paints, adhesives, sealants, and more. Made from strong and durable high-carbon steel, this scraping kit features a uniquely wide and narrow blade for those hard-to-reach areas. In addition, this kit includes two heavy-duty carbon steel blades for flexible and rigid scraping – the flexible design removes soft adhesives, and the rigid design removes hard adhesives. Best of all, the General Purpose Scraping Kit features a universal-fit open-back connector that easily attaches to most oscillating multi-tools, so you can get the job done quickly and efficiently.



Universal Fit

SPECS

Product Number	Width	Cutting Depth
70828	1 5/16 in. (34mm)	2 in. (50mm)
	2 3/64 in. (52mm)	1 in. (26mm)

A series of horizontal dotted lines for writing notes, spanning the width of the page.

PONY | JORGENSEN

ponyjorgensen.com

